

Data Sheet



Article number: 02140000028

Description: Sealing Clamp S 28 W1

Measures

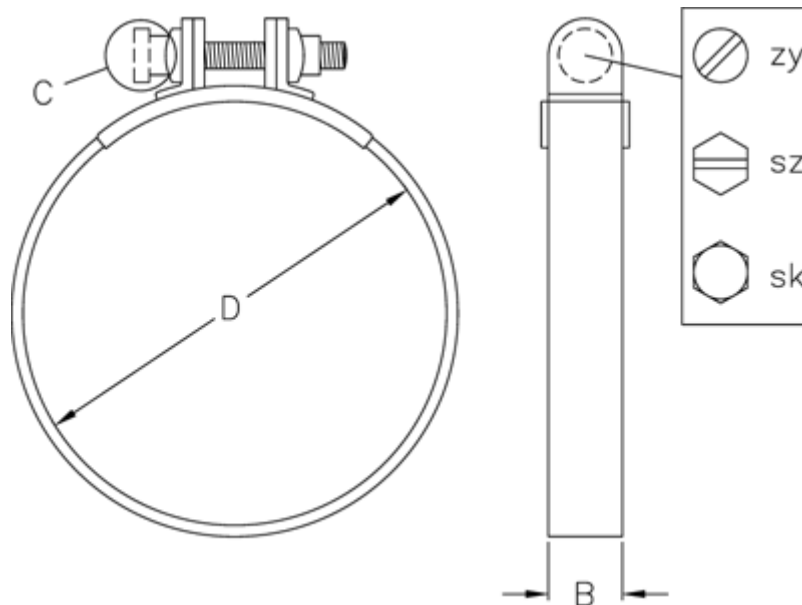

C (screw type) = SZ

Diameter D = 28

Width B = 15